

COMEUP WINCH

Industrial
Winch



INSTRUCTION MANUAL



Limited One (1) Year Warranty Statement

WARRANTY

Comeup Industries Inc. (**COMEUP**) warrants to the original purchaser that **COMEUP** Industrial Winch will be free of defects in material and workmanship for a period of one (1) year from the original date of purchase. All **COMEUP** mounting kits and other accessories carry a one (1) year limited warranty against defects in material workmanship.

This warranty applies only to the original purchaser of the winch. To obtain any warranty service, the purchaser under this Limited Warranty is requested to advise **COMEUP** or its authorized distributors on any claim. The purchaser must provide a copy of the purchase receipt bearing the winch serial number, date of purchase, owners name, email or Tel & Fax, address and purchaser vehicle details. Any products that **COMEUP** determines to be accountable for defective will be repaired or replaced or refund at **COMEUP** sole discretion without charge to buyer upon buyer's compliance with these procedures. In the event of repair or replace, purchaser must send the defective winch or part, with freight prepaid, to **COMEUP** or its authorized distributor. And **COMEUP** will send the serviced product back to purchaser on **COMEUP**'s cost. This warranty does not cover the removal or reinstallation of the winch.

COMEUP takes the responsibility for **COMEUP** winch parts and components to be free from defects in materials and workmanship, but the following portions are hereby excluded and disclaimed. **COMEUP** or its authorized distributors may make reasonable charges for parts and labour for repairs or resumption in the following portions not covered by this limited warranty.

- (1). All warranties of wire rope assembly after initial use
- (2). All warranties of fitness for a particular purpose
- (3). All warranties of the product's finish
- (4). All warranties of merchantability

The limited warranty does not cover any failure that results from improper installation/operation, third party part substitution, purchaser's alteration or modification on **COMEUP** winch. This warranty is void when **COMEUP** serial number plate is removed or defaced.

COMEUP's liability to the purchaser under the winch purchases for any loss or damage howsoever and whatsoever arising shall not exceed the price of the initial winch purchase receipt. **COMEUP** shall not in any event be liable to the purchaser for any consequential and/or indirect loss or damage whether for loss or for profit or otherwise, costs, expenses or other claims for consequential compensation whatsoever and whether caused by negligence of **COMEUP** employees, distributors and their employees or otherwise. **COMEUP** reserves the right to change product design without notice. In situations in which **COMEUP** has changed a product design, **COMEUP** shall have no obligation to upgrade or otherwise modify previously manufactured products.

COMEUP WINCH

Industrial Winch

Thank you for purchasing a **COMEUP** Winch. This manual covers operation and maintenance of the winch. All information in this publication is based on the latest production information available at the time of printing. We reserve the right to make changes without notice because of continued product improvement.

The winch has been designed to give safe and dependable service if operated according to the instructions. Please read and understand this manual before installation and operation of winch. Careless winch operation can result in serious injury or property damage.

When requesting information or ordering replacement parts, always give the following information:

1. Winch Model and Voltage
2. Serial Number
3. Item. No. and Part Number
4. Part Description



WARNING

1. The winch is a very powerful machine. Treat with extreme care and observe all caution and warnings.
2. The winch is rated at the first layer of wire rope on the drum for intermittent-periodic duty.
3. The winch is not to be used to lift, support or otherwise transport personnel.
4. A minimum of five (5) wraps of rope around the drum is necessary to support the rated load.
5. Keep clear of winch, rope, hook, and fairlead while operating.
6. Wire rope can break without warning. Always keep a safe distance from the winch and rope while under a load.
7. Failure to adequately align, support, or attach winch to a suitable mounting base could result in a loss of efficiency of performance or damage the winch, wire rope and mounting channel.

I. Safety Requirement

► General Rules

- ⚠ In some cases, the operator of a winch may be required to have qualifications according to applicable laws and ordinances.
- ⚠ Check safety and environmental conditions prior to and during use.
- ⚠ Only use correctly rated wire rope in construction, strength. Inspect for damage and/or defects before use.
- ⚠ Don't use an unsuitable hook and snatch block for rope.
- ⚠ The operator must remain with the winch during operation.
- ⚠ The winch duty rating is S3 (intermittent-periodic).
- ⚠ Do not use the winch as a lifting device or a hoist for vertical lifting and moving people
- ⚠ Ensure that the winch is connected to the correct power source such as hydraulic or 12/24V DC.
- ⚠ Do not exceed maximum line pull ratings. Shock load must not exceed these ratings.
- ⚠ Keep hands clear of wire rope and roller fairlead opening.
- ⚠ Pull from an angle below 3° in the horizontal plane to straighten up the vehicle or load.
- ⚠ Always use leather gloves when handling the wire rope.
- ⚠ When winching, always use a recovery damper. Place over the wire rope in the middle third of its length.
- ⚠ A wire rope should be replaced if it shows signs of excessive wear, broken strands, corrosion or any other defects.
- ⚠ If the winch fails to pull a load under normal conditions, stop the operation within 30 seconds, or motor damage may occur.
- ⚠ Check that the clutch T-handle is in the "Engaged" position during and after use.
- ⚠ Remove the remote control from the winch when not in use.
- ⚠ Do not wrap the wire rope around the load and back onto itself. Always use a tree truck strap.
- ⚠ Keep hands and clothes away from the winch, wire rope, and roller fairlead.
- ⚠ Never unplug the remote control when winching a load.
- ⚠ To avoid insufficient power when winching a load, the vehicle should be running and in neutral.
- ⚠ If noise or vibration occurs when running, stop the winch immediately and return it for repair.
- ⚠ The rope shall be wound in according to drum rotation sticker or refer to owners manual.

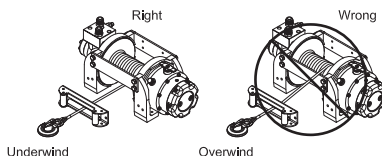
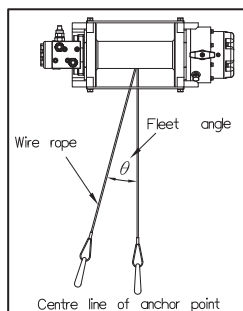
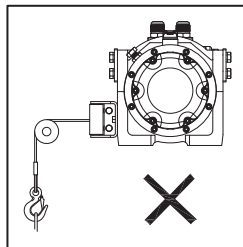

II. Hydraulic System Installation

(Powered by PTO / power take off unit driven pump)

For HV winch

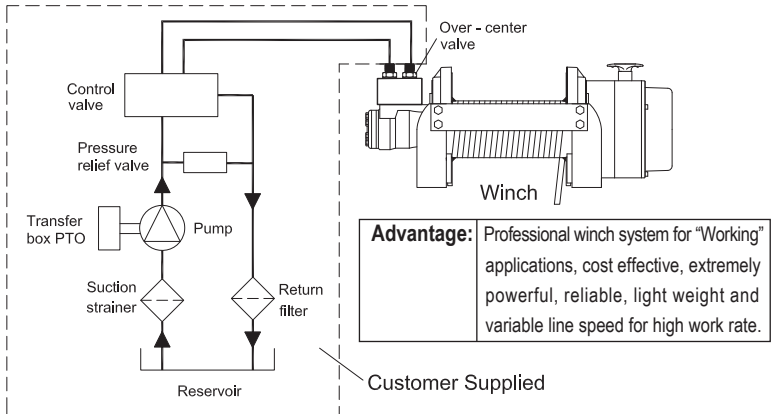

For Bison winch

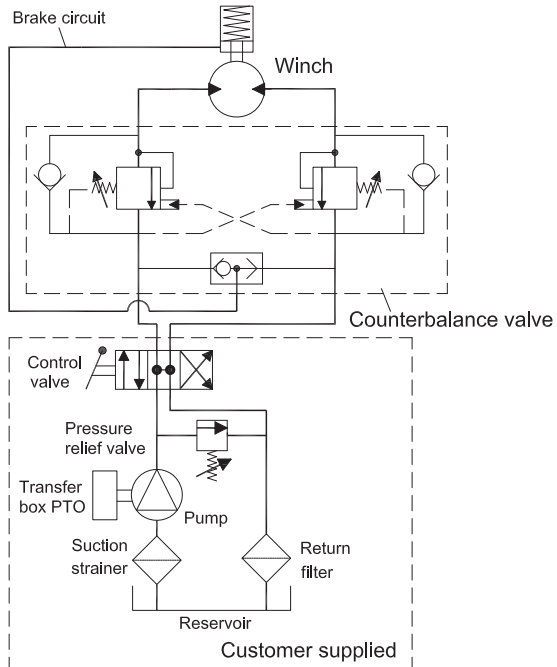

► **Hydraulic Fluid**

- The hydraulic fluid should be a high grade, petroleum based fluid, with rust, oxidation and wear resistance. Fluid cleanliness and operating viscosity are critical to winch reliability, efficiency and service life.

► **Hydraulic Pump**

- To maintain the maximum performance, the hydraulic pump must supply the maximum flow of hydraulic fluid at the hydraulic pressure stated in specification.
- With a max. oil supply mentioned on the instruction manual at top motor rpm and the pump must be capable of delivering the operation pressure mentioned on the instruction manual too.

► **Hydraulic Control Valve**

- The control valve must have a four-way spring return to neutral feature, which provides for open flow from the pressure ports of the winch to the reservoir in neutral position of the control (Applicable both motor spool and cylinder spool).

► **Hydraulic Pressure Relief**

- The hydraulic system requires a pressure relief set at the operating pressure.
- Failure to use the correct pressure and flow may result in damage to the winch, property or personal injury.

► **Hydraulic Reservoir**

- The hydraulic reservoir has sufficient capacity to provide good heat dissipation in order to prevent over-heating of the hydraulic fluid.
- Must be fitted with an oil filler device comprising strainer and filter and a dip stick. The capacity of the tank should be at least 60 liters.

► **Over-Center Valve / Counterbalance Valve**

- Give smoothly controlled winch out when under load and to provide full dynamic braking. It must be installed to hold full load.
- The Port A of over-center valve means the inlet port of oil from reservoir and the Port B meaning the return port of oil to reservoir.
- Over-center valve is a standard accessory for HV winch and counterbalance valve for Bison winch.

► **Hydraulic Hoses**

- The following hydraulic hoses are recommended for maximum efficiency of the hydraulic winch. The bigger nominal bore hose, the better winch performance.
- All hose lengths are kept to a minimum because pressure and flow loss is increased as hose length increases.
- Pressure and return lines in excess of 3.5 meter (11.5") should be compensated with an increase in nominal bore size. Motor drain line pipe shall be rated at 1/4" BSP N.B.
Inlet line 1 1/4" – 1 1/2" nominal bore (N.B.) from reservoir to pump
Return line 1" (N.B.) from control to reservoir
Pressure hoses 1/2" (N.B.) from control valve to over-center valve, for all Hydraulic winch except Bison 50.
3/4" (N.B.) for Bison 50.
Motor drain line pipe... 1/4" BSP N.B.

III . Electric System Installation

Attach the black lead firmly to the negative (-) battery terminal and red lead to the positive (+) battery terminal. The voltage drop for the winch motor must not exceed 10% of the nominal voltage of 12/24V DC. The recommended battery shall be 650 CCA minimum and battery lead shall be 2 AWG (America Wire Gauge for 38 mm² in area) at least, otherwise a considerable voltage drop will be happened.

For Wolf Winch

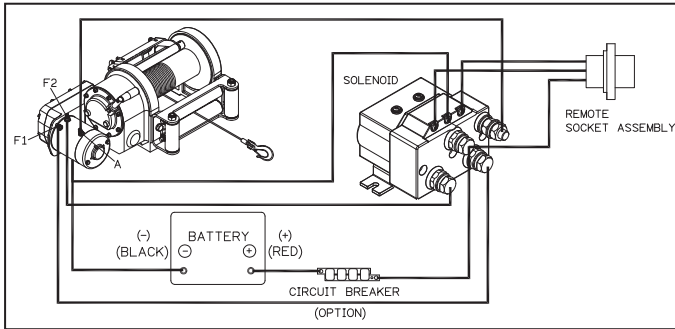

For Rhino Winch

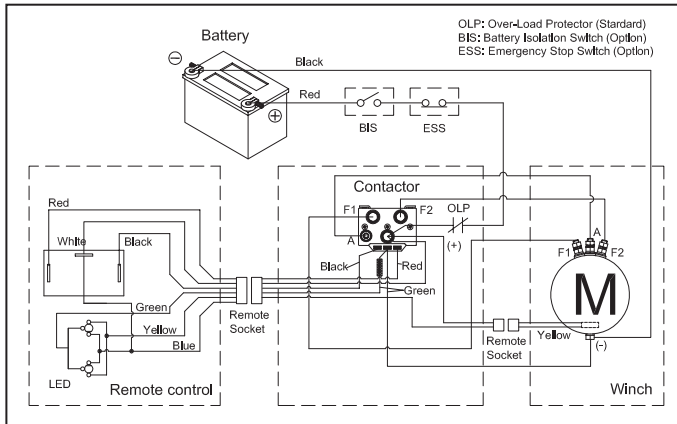

IV. Winching Principles

► Calculating Fleet Angle

To obtain the best wire rope service, the direction of pull will be on a horizontal within ± 3 degrees and perpendicular to be centerline of the winch drum within ± 3 degrees. If the fleet angle is bigger than the recommended angles, a good spooling cannot be obtained as the rope will spoon on to one side of the rope drum.

► Load Rating

Load and speed varies according to how much wire rope is on the drum. The first layer of rope on the drum delivers the slowest speed and the maximum load. The top layer of rope on the drum delivers the maximum speed and the minimum load.

For this reason, all industrial winches are rated at their first layer capacities.

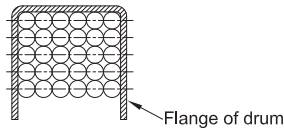
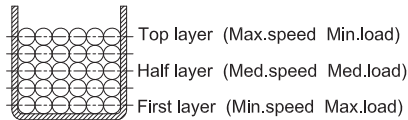

According to EN 14492-1 Section 5.7.2, the flanged drum end plates shall protrude beyond the rope wound on the drum at the top layer by at least $1.5 \times$ the nominal rope diameter..

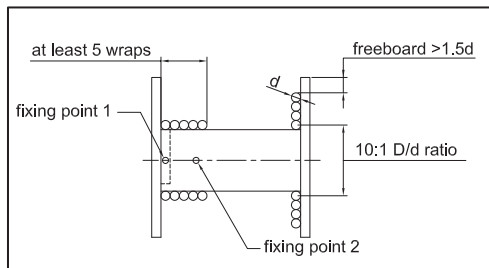

► Duty Cycle Ratings

All industrial winches are rated at S3 10%ED & 1min/10min rating intermittent periodic duty.

► **Securing Anchor Point**

When choosing an anchor point, select a safe and firm point such as a tree, stump or rocks. If using a winch to retrieve another vehicle, the rescue vehicle is considered the anchor point and should be made secure.

The anchor point must be strong enough to hold the gross weight of the vehicle and be positioned to keep the fleet angle between the centre of the anchor point and the wire rope maintained less than 3°. Always use a tree trunk protector strap to prevent ring barking the tree and damaged to the wire rope.

► **Required Pulling Force**

You need a winch powerful enough to overcome the weight of your vehicle with the added resistance caused by the obstacle, moving water, mud, snow, sand or on a steep hill.

As a general guide, you need a winch with a maximum line pull of at least 1.5 times greater than the gross vehicle weight.

There are three factors listed that influence the line pull effect required to recover the vehicle. The values and calculations in this section are approximate and are for reference only.

- a). Gross vehicle weight
- b). Type of the surface to be traversed
- c). Gradient to overcome

In recovery and loading the winch is used to pull something, the required pulling force (RPF) can be calculated according to the formula:

$$RPF = (Wt \times S) + (Wt \times G)$$

Where: Wt = The gross vehicle weight

S = The type of the surface to be traversed

G = The gradient to overcome

Surface Type	Surface Drag (S)
Metal	0.15
Sand	0.18
Gravel	0.20
Soft Sand	0.22
Mud	0.32
Marsh	0.52
Clay	0.52

Gradient	Angle (°)	Gradient (G)
5%	3°	0.06
10%	6°	0.11
20%	11°	0.2
30%	17°	0.3
50%	26°	0.44
70%	35°	0.58
100%	45°	0.71

For example, if a vehicle weighing 3,000 kg is winched up an incline by 100% on the marsh road, the above formula would be used as follows:

Where Wt: 3,000 kg, S: 0.52 G: 0.71

$$RPF = (Wt \times S) + (Wt \times G)$$

$$= (3,000 \text{ kg} \times 0.52) + (3,000 \text{ kg} \times 0.71)$$

$$= 1,560 \text{ kg} + 2,130 \text{ kg}$$

$$= 3,690 \text{ kg of effect required to recover the vehicle.}$$

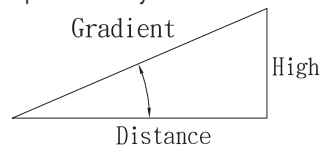

A gradient of 10% is a rise of one meter in ten meters (High / Distance)

► **Winching V.S. Hoisting. A pulling winch should not be used for lifting.**

Please refer to our website to view our full range of lifting winches

V. Standards Compliance

► **Comeup Industrial Winches comply with the following regulations**

1. European Standards of EN 14492-1 for Power Driven Winches came to effect from 29th. December 2009
2. The latest Machinery Safety regulations of 2006/42/EC for machinery Directive.
3. The latest Machinery Safety regulations of 2004/108/EC for EMC Directive.
4. SAE International Surface Vehicle Standard J706

► **Extracts from the Directive & Comeup compliance:**

1. EN 14492-1 Section 5.15.6 Wire Rope
Wire rope minimum break to be twice winch rating
2. EN 14492-1 Section 5.7.2 Rope Drum
Rope drum mean diameter to be 10 times the diameter of the wire rope
3. EN 14492-1 Section 5.7.6 Rope Fastening onto the rope drum
Rope attachment to withstand 2.5 times the winch rating
Rope must have at least two wraps winding before fixing point
4. EN 14492-1 Section 5.15.5 Brake
Winch to hold full rated load
5. EN 14492-1 Section 5.15.2 Rated Capacity limiters
The thermal overload cutout limit the driving power of the motor prevents overloading

► **To comply with EN 14492-1, the following optional accessories must be fitted to all winches**

- Wire rope with 1,960 N/mm² grade
- Rope drum cover
- Emergency stop kit
- Isolator switch

When using and installing a winch, the owner or end user shall ensure that all legal requirements are completely complied with

VI. Accessories

► **Roller Fairlead**

The use of 4 ways roller fairlead can eliminate the contacting friction because the fairlead rollers contact with the wire rope. But the fairlead does not insure the wire rope will wind onto the drum in an orderly manner. The proper fleet angle within 3° must be maintained for the wire rope to wind onto the drum in an orderly manner. If the proper fleet angle is not maintained, it can result in damage to the winch and wire rope.

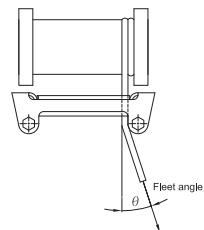

► **Cable Tensioner**

The purpose of cable tensioner device is to keep the wire rope tight on the drum while the winch is in free spool mode or while there is no load on the wire rope.

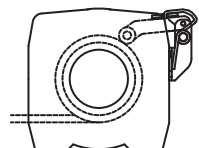

► Snatch Block

An important aid to successful winching is the use of snatch block, which can be used to increase the pulling power of a winch or change the direction of a pull.

A winch double lined with a snatch block creates a mechanical leverage cutting the effort required by half.

The double line pull shows self recovery using a snatch block attached to an anchor point; the pull applied to the vehicle is almost twice as much as the line pull of the winch.

The use of one snatch block shows an indirect pull where the vehicle is limited due to unsuitable ground or obstruction.

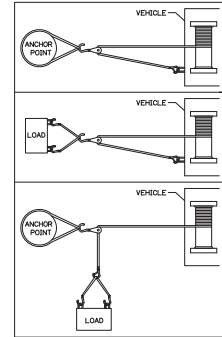

► Recovery Damper

A recovery damper is a safety device designed to help eliminate the possibility of injury or property damage in the event of a wire rope failure. Place in the middle third of a live rope. The damper can help absorb the energy in the rope and reduce the likelihood of injury or damage.

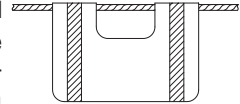

VII. Hydraulic Operation (For Yak Winch and HV Winch)

► Manual Clutch Function

The clutch allows rapid pay-out of the wire rope for hooking onto a load or anchor points and is operated by a clutch T-handle.

The clutch T-handle must be in the “Engaged” position before winching.

- 1). To disengage, lift/pull the clutch T-handle up and turn it at 90° counter-clockwise rotation to the “Disengaged” position, wire rope can now clutch off the drum.
- 2). To engage, lift/pull the clutch T-handle up and turn it at 90° clockwise rotation to the “Engaged” position.
- 3). If a clutch T-handle can't be properly locked in the “Engaged” position, rotate the drum to make the clutch device engage to the gear train.
- 4). Wear leather gloves and use a strap when guiding the wire rope on and off the drum.

• For Yak Winch

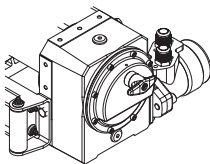

(Engaged)

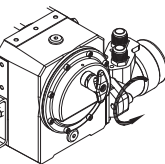
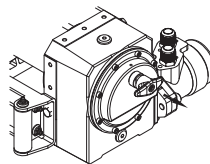

(Disengaged)

- For HV Winch

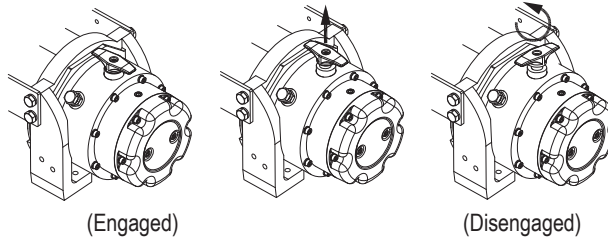

► Replace T type clutch kit

1. Loosen the socket set screw securing the clutch
2. T-handle threads in the gear housing.
3. Remove the T-handle from the gear housing.
4. Thread the new clutch assembly completely into the gear housing.
5. Tighten the socket set screw securing the clutch mechanism threads into the gear housing.

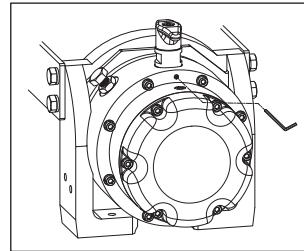

► Air Clutch Function

The air clutch must be in the “Engaged” position before winching.

- 1). Apply air pressure to the PF-1/8”-28 fitting for HV winch or PF-1/4”-19 fitting for Bison winch with 120 psi (8.3 bar).
- 2). To disengage the drum by operating the air control valve to pull out the wire rope by hand. Pull out the wire rope but leave at least 5 wraps on the drum.
- 3). To engage the drum by moving the control valve lever to the appropriate position. Do not attempt to pull a load until the air clutch in the “Engaged” position.
- 4). Wear leather gloves and use a strap when guiding the wire rope on and off the drum.
- 5). It cannot be clutched when the load is under load.

► Mounting reposition

Yak series winch motor can be mounted by 90° upward to shorten the horizontal space. The SHELL Omala 460 must be increased by 0.2 litre in the gearbox to have the worm gear sets lubricated fully.

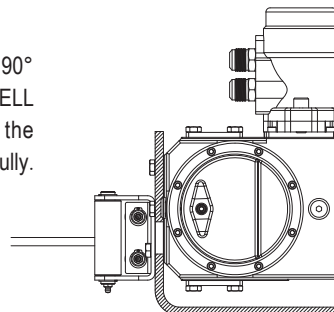

► Lubrication

- **For Gear Box**

All moving parts in the winch are permanently lubricated at the time of assembly. Under normal conditions factory lubrication will suffice. The lubricant for gear box shall be filled after repair or disassembly.

- **For Brake Assembly**

The lubrication is an important component in insuring the long life of your winch and the type of lubricant will have a great influence. The initial lubricant should be changed after the first 10 hours of operation. Subsequent changes should be scheduled annually.

- **For Clutch, Roller Fairlead and Wire Rope**

The lubrication for clutch, roller fairlead and wire rope can use light oil in the temperature of -10°C to 50°C.

Winch Components		Gear Box	Brake Assembly
Lubricant	Type	Oil	Nil
	Recommended	Shell Omala 460	Nil
	Viscosity(cSt)	679 mm ² /s at 40°C 37.2 mm ² /s at 100°C	Nil
Quantity	Yak 5	0.5 litre	Nil
	Yak 7	0.5 litre	Nil
	Wolf 8.5/12.0	0.9 litre	Nil

Winch Components		Gear Box	Brake Assembly
Lubricant	Type	Grease	Oil
	Recommended	Castrol Alpha Spheerol L-EP 2	Castrol Alpha Series, SP-460
	Viscosity(cSt)	150 mm ² /s at 40°C	457.81 mm ² /s at 40°C 29.83 mm ² /s at 100°C
Quantity	HV-8	0.3 litre	0.12 litre
	HV-10	0.3 litre	0.12 litre
	HV-12	0.6 litre	0.3 litre
	HV-15	0.6 litre	0.3 litre
	Bison 20	0.75 litre	Nil
	Bison 30	1 litre	Nil
	Bison 50	2 litre	Nil

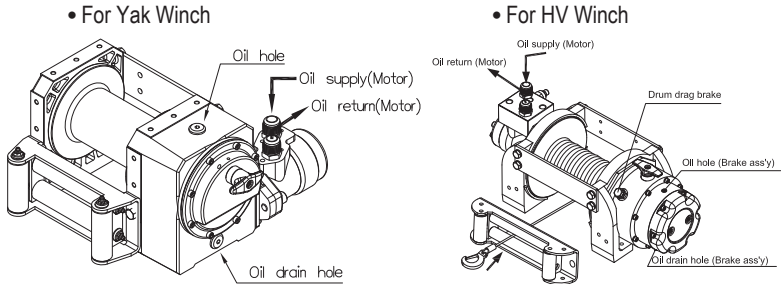

Remark: 1. The purpose of drum drag brake is to prevent the drum from overrunning the wire rope when “free-spooling” and it will not be relied on to control or hold a load.
 2. The drum drag brake is only available for HV winch.

VIII. Electric Operation (For Rhino Winch and Wolf Winch)

► Control with Thermal Sensor – Warning LEDs (for Rhino Winch Only)

The warning LEDs are shown on the remote control. You shall stop operation and allow winch to cool (Green LED) when the Red LED was illuminated.

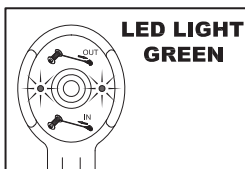

(Normal winching)

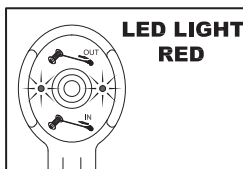

(Abnormal winching)

Functions	LEDs
Plug in the Winch	Green
Normal Winching Conditions	Green
Abnormal winching Conditions	Red
Stop the Winch	Green

► Battery Recommendations

A fully charged battery and good connections are essential for the proper operation of your winch. The minimum requirement for battery is 650 cold cranking amp.

► Cable-in / Cable-out Operation

- 1).To determine “Cable - Out”, trigger → out
- 2).To determine “Cable - In”, trigger ← in
- 3).To stop winching, release the trigger

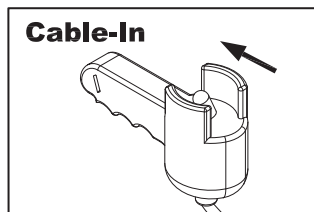
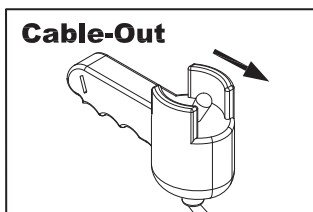

► Clutch Function

The clutch allows rapid pay-out of the wire rope for hooking onto a load or anchor points and is operated by a clutch T-handle.

The clutch T-handle must be in the “Engaged” position before winching.

- 1). To disengage, lift the clutch T-handle up for Rhino Winch and turn it at 90° counter-clockwise rotation to the “Disengaged” position, wire rope can now clutch off the drum.
- 2). To engage, lift the clutch T-handle up for Rhino Winch and turn it at 90° clockwise rotation to the “Engaged” position.
- 3). If a clutch T-handle can't be properly locked in the “Engaged” position, rotate the drum to make the clutch device engage to the gear train.
- 4). Wear leather gloves and use a strap when guiding the wire rope on and off the drum.

• For Rhino Winch

• For Wolf Winch

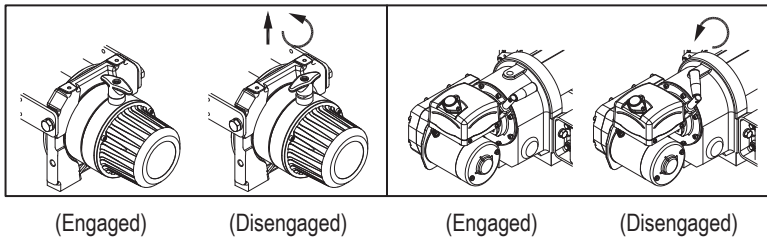

► Wire Rope Replacement

Never use a wire rope of a different size or material. The wire rope end shall be inserted through a hole in the drum and a screw is used to clamp the wire rope in place. This rope attachment is simple and ingenious.

- 1). Disengage the clutch T-handle.
- 2). Spool the entire wire rope, and then remove it from the drum.
- 3). For Yak/HV/Bison/Wolf Winch, place the replacement wire rope through the roller fairlead opening, pass below the drum, and insert it into the hole on the drum core.
 - 3-1). For Rhino Winch, place the replacement wire rope through the roller fairlead opening and drum core. Escape from hole 2 and wind 5 wraps on the drum. Insert the rope to the drum core from hole 1
- 4). Tighten the screw downwards to secure the wire rope.
- 5). The red paint markings on the wire rope means 3 metres remains on the drum.

• For Yak/HV/Bison/Wolf Winch

• For Rhino Winch

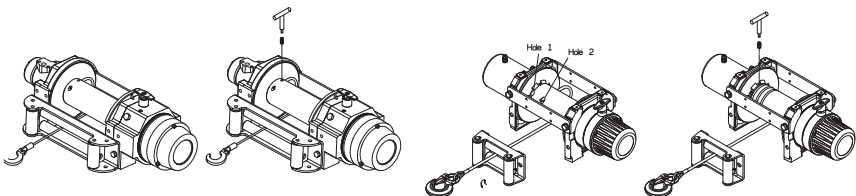

► Brake Adjustment

- For Rhino Winch with Cone Brake System

Under normal use, the brake mechanism will not require any adjustment. If the brake fails to hold a load, the brake disc may be worn and require replacement.

When the brake wears to the point that the load begins to slip, the brake can be adjusted as follows:

- 1). Loosen the bolts and remove the brake cover, take of retaining rings.
- 2). Insert a few washers to maintain the brake spacer between to be 2.2 ± 0.25 mm.
- 3). Make sure to keep the clutch base plate counter-clockwise by 150 – 180 degree.

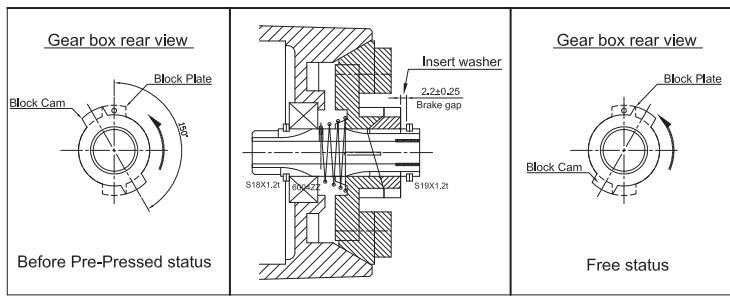

- For Wolf Winch, it was designed by ratchet brake, so no need for further brake adjustment.

► Lubrication

All moving parts in the winch are permanently lubricated at the time of assembly. Under normal conditions factory lubrication will suffice. If re-lubrication of gear box is necessary after repair or disassembly use Shell EP2 or equivalent grease with enough quantity. Clutch T-handle lubricates regularly with light oil. It is not allowed to have brake assembly lubricated.

IX. Maintenance Schedule

- Ensure that a responsible person carries out all inspections as per schedule.
- Inspections are divided into Daily, Monthly and Quarterly.

Classification of check			Item	Checking method	Checking reference	
Daily	Periodical					
	Monthly	Quarterly				
<input type="radio"/>			Installation	Loosening and center run-out of foundation	Checking of installing bolts	Existence of abnormalities
<input type="radio"/>			Remote control	Working	Manual	Reasonable actuation
		<input type="radio"/>		Wearing in contact points	Visual	Free of wear or damage
<input type="radio"/>			Wire rope	Breaking of base wire	Visual	Less than 10%
<input type="radio"/>	<input type="radio"/>			Decreasing of diameter	Visual, measuring (one month)	7% of nominal diameter max
<input type="radio"/>				Deforming or corrosion	Visual	To be not remarkable
<input type="radio"/>				Fastening condition of end	Visual	To be sufficient for hanging up of load
		<input type="radio"/>	Clutch	Wearing of handle	Operating	To be free from remarkable wearing and damage
		<input type="radio"/>	Motor	Staining, damage	Decomposition checking	Existence of abnormalities
		<input type="radio"/>	Brake	Wearing of brake disc	Decomposition checking	To be free from remarkable wearing and damage
<input type="radio"/>				Performance	Visual	Reasonable actuation
		<input type="radio"/>	Gear	Damage, wearing	Decomposition checking	To be free from remarkable wearing and damage
<input type="radio"/>	<input type="radio"/>			Low oil level	Visual	Replenish oil

X. Trouble Shooting

► For Hydraulic Winch (Yak Winch, HV Winch and Bison Winch)

In most cases, the cause of malfunction is found in the hydraulic system. Before the winch is removed from its mounting and disassembled, all of hydraulic system components should be checked for proper function. When checking oil pressure and volume in the hydraulic system, make certain that the hydraulic reservoir is filled to the top level.

1. Hydraulic Oil Volume

The hydraulic oil volume relates to the line speed or rpm of the winch. Therefore if the winch does not produce the specified maximum line speed or drum rpm, a loss of hydraulic flow in the hydraulic system can be analysed. In this condition exists, install a flow meter into the hydraulic system to check the volume supplied to the pressure port of the hydraulic winch motor when the winch control is completely opened.

2. Hydraulic Pressure

The hydraulic pressure relates to the line pull of the winch. Therefore if the winch does not produce the specified maximum line pull, a loss of hydraulic pressure in the hydraulic system can be analysed. In the condition exists, install a pressure gauge into the pressure line leading to the pulling port on the hydraulic winch motor.

3. Troubleshooting chart

Only if the hydraulic system has been checked and found to be in order, use the following indications for possible causes of failure in the winch.

Symptom	Possible Causes	Remedy
Winch will not pull load	Motor may be damaged	Remove and disassembly motor and examine all parts and replace any that are worn or damaged
	No oil supply to winch	Check oil supply line connections and hoses
	System not delivering full pressure to winch	Confirm pump is running to a higher setting
	Winch is Overload	Reduce load to within rated capacity
	The pressure is not adequate to power the load, or the back pressure is too high	Check the pressure on each side of the hydraulic motor
	Winch is mechanically binding up	Loosen, but not remove, the bolts that are attaching the tie bar and support racks. Rotate the drum, making sure that it turns freely without sticking. Tighten the bolts.
	The brake is not releasing	This requires disassembly of the brake assembly. Remove and replace of the brake assembly.
Winch will not pay out	Poor locking of 2nd stage ring gear	Clean any burrs left on the ring gear
	The gear train is mechanically bundling up	This requires disassembly of the brake assembly. Remove and replace of the brake assembly.
	Winch is mechanically binding up	Same as above
	Damaged clutch T-handle linkage	Replace or remove the clutch assembly
Oil leakage	Damaged drum seals	Replace drum seal
	Damaged drum flanges	Replace drum
	Front seal in the hydraulic motor shaft has failed	Replace or repair the motor
Excessive noise	Low oil level	Refill oil
	Oil flow too high	Check oil flow rate
Fail in immediate stop after power off	Fail in installing or damaged over-center valve	Check over-center valve
	Wrong oil flow direction of port A & B on the over-center valve	Check over-center valve
	Damaged brake assembly	Replace or repair brake assembly
Drum noise	Insecure mounting	Check mounting
	Low oil flow	Check flow rate
	Low relief	Check relief valve setting

► For Electric Winch (Rhino Winch and Wolf Winch)

Symptom	Possible Cause	Remedy
Winch will not operate	Cut circuit	Check battery lead
	Weak battery	Recharge or replace battery (at least 650CCA)
	Damaged over-load protector(option)	Replace over-load protector(option)
	Bad connection of wiring	Reconnect tightly
	Damaged contactor	Replace contactor
	Cut circuit on switch	Replace switch
	Damaged motor or worn carbon brush	Replace motor or carbon brush
	Poor or lost connections to motor	Replace wiring or tighten it
Motor runs in one direction	Broken wiring or bad connections	Reconnect or replace wiring
	Damaged or stuck contactor	Replace contactor
	Switch inoperative	Replace switch
Drum will not clutch	Clutch does not disengage	Replace clutch
	Damaged 1 st shaft	Replace 1 st shaft
	Damaged brake cam and disc	Replace brake cam and disc
	Damaged output shaft	Replace output shaft
No brake	The gear train is mechanically binding up	Check to insure the winch is mounted on a flat, rigid surface
	Damaged brake cam and disc	Replace brake cam and disc
	Damaged gear box	Replace gear box
	Broken retaining ring	Replace retaining ring
	Oil leakage into brake cavity	Repair and clean oil leakage
Brake distance is too long	Damaged or inoperative spiral spring	Replace and position spiral spring
	Worn brake disc or loose brake spacer	Replace brake disc or adjust brake spacer according to brake adjustment procedures
Brake will be locked	Oil leakage into brake cavity	Repair and clean oil leakage
	Too much brake disc powder in the brake hub	Clean brake hub
	Over tensioned spiral spring	Adjust tension on spiral spring
Damaged gear box	Stuck between brake disc and gear box	Replace with new brake assembly
	Hit by certain exterior force	Replace the damaged components
	Damaged gear train	Replace the damaged components
Motor runs extremely hot	Over load operation	Stop the winch operation and reduce the load
	Long period of operation	Allow to cool
	Damaged motor	Replace or repair motor
	Damaged or inoperative brake	Replace or repair brake

COMEUP WINCH

COMEUP INDUSTRIES INC.

No.139, Jieyukeng Rd., Ruifang Dist., New Taipei City 22453, Taiwan

TEL:+886-2-24971788 FAX:+886-2-24971699

Email: info@comeup.com.tw

<http://www.comeupwinch.com>

PN 881408 Ver:10

Specifications subject to change without notice