

# COMEUP

# AC Winch

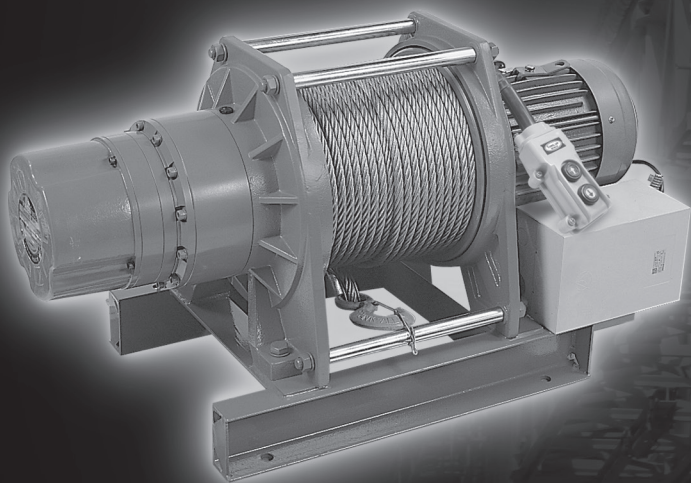

## INSTRUCTION MANUAL





### Limited One (1) Year Warranty Statement

Comeup Industries Inc. ( **COMEUP** ) warrants to the original purchaser that the mechanical components and electrical components of the **COMEUP** Electric Winch will be free of defects in material and workmanship for one (1) year. All **COMEUP** mounting kits and other accessories carry one (1) year limited warranty against defects in material workmanship.

This Warranty applies only to the original purchaser of the winch. To obtain any warranty service, the Purchaser under this Limited Warranty is requested to report **COMEUP** or his authorized distributors of any claims. The Purchaser must provide a copy of the proof of purchase bearing the winch serial number, date of purchase, owners name email, or Tel & Fax, address and registration number. Any product **COMEUP** determines to be defective will be repaired or replaced at **COMEUP** sole discretion without charge to Buyer upon Buyer's compliance with these procedures. Seller or its Authorized Distributors may make reasonable charges for parts and labour for repairs not covered by this Limited Warranty.

**COMEUP** takes the responsibility for all parts and components to be free from defects in materials and workmanship, but the following are hereby excluded and disclaimed:

- (1). All warranties of wire rope assemblies after initial use.
- (2). All warranties of fitness for a particular purpose.
- (3). All warranties of the product's finish
- (4). All warranties of merchantability

The Limited Warranty does not cover any failure that results from improper installation, operation or the Purchaser's modification in design. **COMEUP** reserves the right to change Product design without notice. In situations in which **COMEUP** has changed a product design, **COMEUP** shall have no obligation to upgrade or otherwise modify previously manufactured products.

Thank you for purchasing a **COMEUP** Winch. This manual covers operation and maintenance of the winch. All information in this publication is based on the latest production information available at the time of printing.

### General Safety Precautions

The winch has been designed to give safe and dependable service if operated according to the instructions. Please read and understand this manual before installation and operation of the winch.

Follow these general safety precautions:

- Confirm that the winch complies with the using conditions.
- Keep the winch secure strongly and the rope is not wound to be deviated to the drum.
- Don't use unsuitable pulleys or accessories concerned.
- Don't use unsuitable rope in construction, strength or having any defects.
- Pay attention to the grounding, it provides a path of least resistance for electric current to reduce the risk of shock.
- Check the winch for smooth operation without load before loading operation.
- Make sure the wire rope to be wound evenly in the first layer on the drum, rewind it if a mixed windings in existence.
- If a wire rope is found an uneven winding or accumulated at one side of the drum, align it adequately.





#### **WARNING**

1. The winch is not to be used to lift, support or otherwise transport personnel.
2. A minimum of five (5) wraps of rope around the drum is necessary to support the load rated.
3. The owner and/or the operator shall have an understanding of these operating instructions and the warning before operating the electrical winch. Failure to follow these warnings may result in loss of load, damage to the winch, property damage, personal, or fatal injury.
4. The owner shall retain this manual for further reference to important warnings, installation, operating and maintenance instructions.

# I. Installation Precaution

## ► General Safety Precaution

 <b>DANGER</b>	
	The following environmental conditions may result in the possible causes of hoist trouble.

- Low temperature below  $-10^{\circ}\text{C}$  ,high temperature above  $40^{\circ}\text{C}$  or humidity above 90% conditions

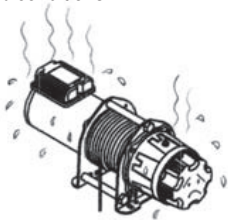

※Cause malfunction of spare parts

- In an organic chemistry or explosive powder conditions



※Cause explosion

- In heavy acid or salty conditions
- In rain or snow conditions

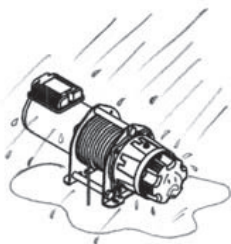

※Cause malfunction of spare parts  
※Cause rust or short circuit

- In a heavy general powder

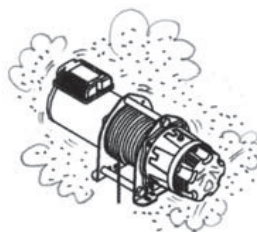

※Cause malfunction of performances

## II. Handling Precautions

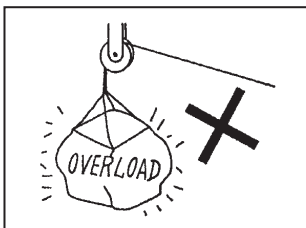

- It is forbidden to lift loads above the rated capacity of the winch

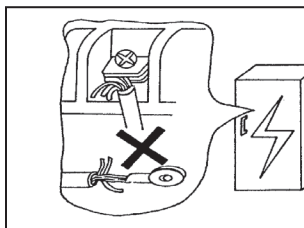

- Do connect the power lead on the main power source directly and fasten them

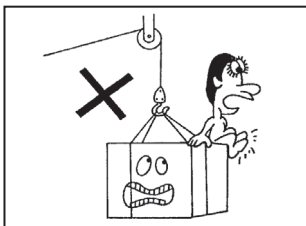

- Ban on transporting persons

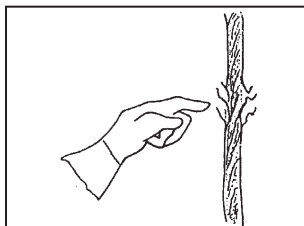

- Don't ignore fault accessories

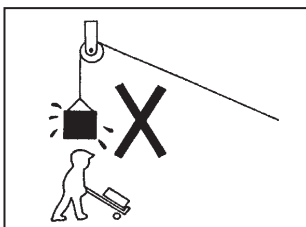

- Don't stand under winching operation



- Don't operate hoist in rain or snow

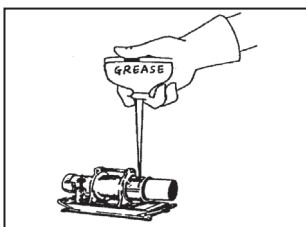

- Do perform maintenance on schedule

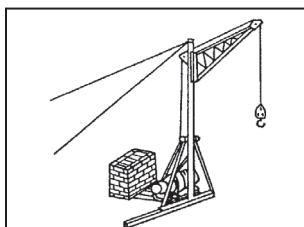

- Do anchor crane with ballasted container and wire rope

### III. Winching Principles

#### ► Percentage Duty Cycle

 <b>WARNING</b>	
	Never hoist over the rated percentage duty cycle.

The life of the winch is depending on the conditions of the load and working frequency. In the long time operation, make sure to use the machine within its continuous ratings. Continuous ratings means the percentage duty cycle (%ED) is subject to the rated voltage, rated frequency and a 63% of rated load.

$$\text{Percentage duty cycle (\%ED)} = \frac{T_b}{T_b + T_s} \times 100 (\%)$$

T<sub>b</sub>: total sum of overall loadings operating hours.

T<sub>s</sub>: total sum of stopping hours.

T<sub>b</sub> + T<sub>s</sub> = approximately 1 to 10 minutes.

For this reason, all electric winches are rated at a 25% percentage duty cycle (%ED).

#### ► Load Rated

Load and speed vary according to how much wire rope is on the drum. The first layer of rope on the drum delivers the slowest speed and the maximum load. A full drum delivers the maximum speed and the minimum load. For this reason, all electric winches are rated at their top layer of wire rope on the drum.

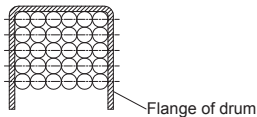
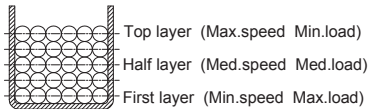

#### ► Calculating Head Loads

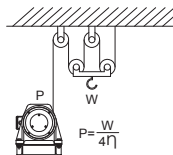
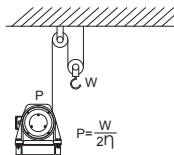
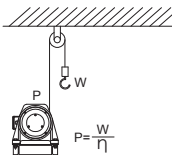

- P: Rope tension
- η: Sheave efficient
- θ: Angle
- W: Load
- μ: Friction factor

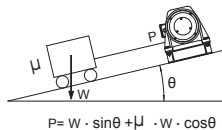
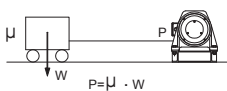

Use a tackle block for double fall operation to increase the rated load by approximately 85% but its speed will be deducted by half accordingly.

## ► Calculating Fleet Angle

- The winch should be mounted as close to centre and as perpendicular as possible to the direction of the line pull. This will keep the wire rope fleet angle centre on the drum as small as possible.
- If the proper fleet angle is not maintained, the wire rope could wind onto one side of the drum.

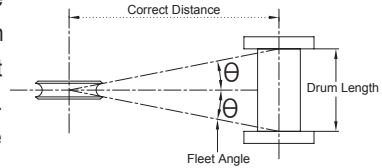

Experience has shown that the best wire rope service is obtained if the maximum fleet angle is not more than 1.5° for smooth drum and 2° for grooved drum.

For example, the correct distance varies according to drum length.

Model	CP-200/250/300, CWG-30075	CP-500/500T	CWG-10077	CWG-10151/30151, CP-750T/900T
Drum Length	110 mm	220mm	150 mm	240 mm
Correct Distance	2.09 m at least	4.18 m at least	2.85 m at least	4.56 m at least

Model	CWG-30375	CWG-30565	CWG-30750	CWG-31500	CWG-34000
Drum Length	230 mm	312 mm	312 mm	405 mm	680 mm
Correct Distance	2.09 m at least	5.92 m at least	5.92 m at least	7.7 m at least	12.92 m at least

## ► D/d Ratio

It means ratio of pitch circle diameter of drum to the rope diameter.

In principle, a 12:1 D/d ratio is suggested for most pulling application and a 15:1 D/d ratio for lifting and lowering applications. For example, a CP-200 comes with a 94 mm dia. drum and a 6 mm x 30 m wire rope, therefore its D/d ratio is calculated as follow.

$$D/d \text{ ratio} = (94 + 6 \text{ mm}) / 6 \text{ mm} = 16.67 \text{ times}$$

## ► Rope Safety Factor

The working coefficient of the wire rope shall be determined from the ratio of the minimum breaking force of the rope and the maximum possible lifting capacity.

In principle, a 3.5 times of rope safety factor is suitable for most pulling applications and a 5 times for lifting and lowering applications. For example, a CP-200 comes with a 6 mm x 30 m wire rope with 2,010 kg minimum breaking force, therefore its rope safety factor is calculated as follow.

$$\text{Rope safety factor} = 2,010 \text{ kg} / 200 \text{ kg} = 10 \text{ times}$$



## IV. Compliance with EU Directives

### ► Electric Winches shall comply with the following regulations

1. European Standards of EN 14492-1 for Power Driven Winches came to effect from 29<sup>th</sup> December 2009
2. European Machinery Directive 2006/42/EC.
3. European Directive on Electromagnetic Compatibility ( EMC ) 2004/108/EC
4. European Low Voltage Directive ( LVD ) 2006/95/EC

### ► Extracts from the Directives

1. EN 14492-1 Section 5.15.6 Wire Rope  
Wire rope minimum break to be twice winch rating
2. EN 14492-1 Section 5.7.2 Rope Drum  
Rope drum mean diameter to be 10 times the diameter of the wire rope and the flanged drum end plates shall protrude beyond the rope wound on the drum at the top layer by at least 1.5 x the nominal rope diameter.
3. EN 14492-1 Section 5.7.6 Rope Fastening onto the rope drum  
Rope attachment to withstand 2.5 times the winch rating  
Rope must have at least two wraps winding before fixing point
4. EN 14492-1 Section 5.15.5 Brake  
Winch to hold full rated load
5. EN 14492-1 Section 5.15.2 Rated Capacity Limiters  
Winch for lifting and lowering purpose with a rated capacity of 1,000 kg or more shall be fitted with a rated capacity limiter to prevent overloading of the winch

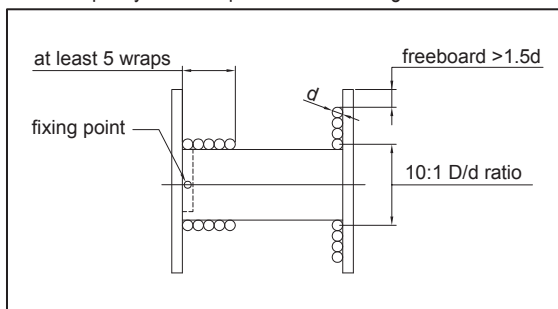

### ► To comply with EN 14492-1, the following optional accessories must be fitted to all winches

- Low voltage control
- Remote control w/ an emergency stop button
- Rope drum cover
- Up and down limits protection devices

When using and installing a winch, the owner or end user shall ensure that all legal requirements are completely complied with.

## V. Working Method

### ► Power Lead and Switch Cord Sections

Winch Model	Power Lead	Remote Control				Low Voltage Control
		Direct Control		Indirect Control		LV-320 or LV-360
		W/Switch CPB-213	W/Switch PB-331	W/Switch CPB-161	W/Switch PB-306	
CP-200/250/300	1.5 mm <sup>2</sup>	* 1.25 mm <sup>2</sup>	1.25 mm <sup>2</sup>		1.25 mm <sup>2</sup>	
CP-500	3.5 mm <sup>2</sup>	* 3.5 mm <sup>2</sup>	3.5 mm <sup>2</sup>		1.25 mm <sup>2</sup>	
CP-500T	3.5 mm <sup>2</sup>	* 3.5 mm <sup>2</sup>	3.5 mm <sup>2</sup>	1.25 mm <sup>2</sup>	1.25 mm <sup>2</sup>	
CP-750T	3.5 mm <sup>2</sup>			* 1.25 mm <sup>2</sup>	1.25 mm <sup>2</sup>	* LV-320
CP-900T	3.5 mm <sup>2</sup>			* 1.25 mm <sup>2</sup>	1.25 mm <sup>2</sup>	* LV-320
CWG-10077	3.5 mm <sup>2</sup>	* 3.5 mm <sup>2</sup>	3.5 mm <sup>2</sup>		1.25 mm <sup>2</sup>	
CWG-30075	3.5 mm <sup>2</sup>	* 1.25 mm <sup>2</sup>	1.25 mm <sup>2</sup>		1.25 mm <sup>2</sup>	
CWG-10151	5.5 mm <sup>2</sup>	* 3.5 mm <sup>2</sup>	3.5 mm <sup>2</sup>		1.25 mm <sup>2</sup>	
CWG-30151	3.5 mm <sup>2</sup>	* 2.0 mm <sup>2</sup>	2.0 mm <sup>2</sup>		1.25 mm <sup>2</sup>	
CWG-30375/30565/30750/31500	5.5 mm <sup>2</sup>			* 1.25 mm <sup>2</sup>	1.25 mm <sup>2</sup>	* LV-320 or LV-360
CWG-34000	8.0 mm <sup>2</sup>			* 1.25 mm <sup>2</sup>	1.25 mm <sup>2</sup>	* LV-360

Remarks: 1. \* means standard version on delivery.

2. Switch PB-331 and PB-306 are equipped with an emergency stop function.
3. The selections of LV-320 and LV-360 vary according to winch model and power source.
4. The length of power lead is subject to the distance less than 20 meters.
5. The length of switch cord is subject to the distance less than 20 meters.
6. For any other cases, please use a bigger section of power lead or switch cord.

### ► Pendant Switch Selections

Switch Type	Direct Control		Indirect Control	
	*CPB-213	PB-331	*CPB-161	PB-306
Rated Amp.	30 A	30 A	3 A	3 A
Contacts	3a	3a + Emergency Stop ( 1a1b)	2a	2a + Emergency Stop ( 1a1b)
Applicable Winches	CP-200/250/300/500/500T, CWG-10077/10151/30075/30151		CP-750T/900T, CWG-30375/30565 CWG-30750/31500/34000	

Remarks: 1. \* means standard version on delivery.

### ► Low Voltage Control Selections

Type	LV-320, Plastic Cover		LV-360, Steel Cover	
IP Grade	IP55, Comes with magnetic switch, relay and transformer		IP44, Comes with magnetic switch, relay and transformer	
Ratings	5 kw	7.5 kw	7.5 kw	15 kw
Applicable Winches	CWG-30375, CP-750T/900T	CWG-30565/30750 31500,380-440V	CWG-30565/30750 31500,220V	CWG-34000

## ► Grounding

To prevent the risk of electric shock, the power plug must be plugged into a matching outlet and grounded in good condition.

## ► Up and Down Switching

To lift a load, press ↑ button and drum will rotate as shown below operation.

To lower a load, press ↓ button and drum will rotate as shown below.

To stop winching, release ↑ or ↓ button.

To have an emergency stop function, press the emergency stop button (option). Rotate the button clockwise for returning.

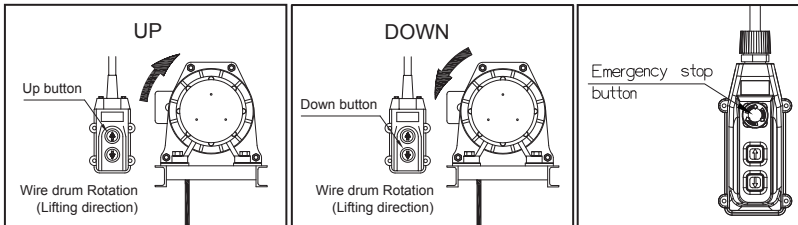

## ► Wire Rope Replacement

- Insert the wire rope into the hole of drum and fix it with a P. T. screw, then press ↑ button of switch for rotate the drum in the lifting direction.
- Wind the wire rope accurately around the drum, and an irregular winding will cause the load to be swing, thus damaging the wire and reducing the life of winch.
- When replacing the rope w/weight hook for winch rated less than 500 kg, according to the following procedures. It is only available for CP-200/250/300/500S/500T and CWG-10075/10151/30075.30151

\*Pull out an R-dowel "D" from the round head pin "C".

\*Pull out a round head pin "C" from hook body "A".

\*Put a wire rope "B" into the hole of hook body "A", and insert a round head pin "C" through wire rope and fixture hole of hook body "A".

\*Insert an R-dowel "D" into the hole of round head pin "C".

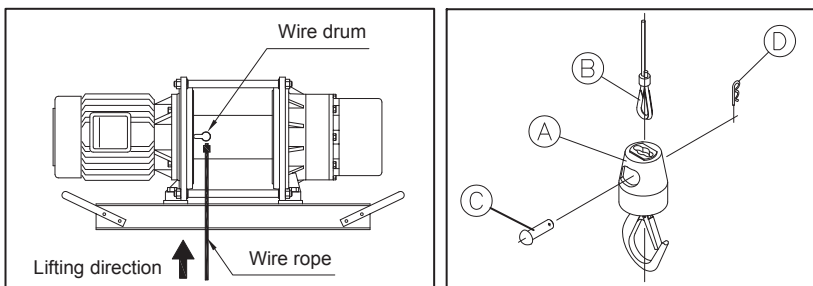

► **Wire Rope Selections**

Winch Model	Lifting Capacity at 50Hz kg	Recommended Wire Rope				
		Dia. mm	Length ( m )	Const.	Minimum Breaking Strength kg	Safety Factor at 50Hz
CP-200	200	6	30	6 x 19	2,010	10
CP-250	250	6	30	6 x 19	2,010	8
CP-300	300	6	30	6 x 19	2,010	6.7
CP-500/500T	500	7	60	6 x 19	2,700	5.4
CP-750T	750	9	60	6 x 24	3,750	5
CP-900T	900	10	30	6 x 24	4,640	5.1
CWG-10077	300	6	60	6 x 19	2,010	6.7
CWG-10151	400	9	60	6 x 24	3,750	9.3
CWG-30075	300	6	30	6 x 19	2,010	6.7
CWG-30151	500	9	60	6 x 24	3,750	7.5
CWG-30375	900	10	60	6 x 24	4,640	5.1
CWG-30565	1,100	12	100	6 x 24	6,680	6
CWG-30750	2,200	16	100	6 x 24	11,900	5.4
CWG-31500	3,500	18	150	6 x 24	15,000	4.2
CWG-34000	5,000	22.4	200	6 x 24	23,300	4.6

Remarks: The recommended wire rope means standard version on delivery. Other size wire rope shall carefully consider the safety factor and D/d ratio for rope...

► **Oil Replacement**

Gear lubrication is an important component in insuring the long life of your winch. Winch are pre-lubricated at the factory and do not require initial lubrication. Re-lubrication interval depends upon service, 250 working hours of a year, or after repair or disassembly. The lubricant for gear box was recommended by Castrol Alpha Spheerol L-EP 2 or HT-740-0 grease, or Castrol Alpha Series, SP-220/460 oil recommended.

Model CP-	200	250	300	500	500T	750T	900T	CWG-30075
Lubricant	L-EP2	L-EP2	L-EP2	L-EP2	L-EP2	HT-740-0	HT-740-0	L-EP2
Q'ty	0.5 lt	0.5 lt	0.5 lt	0.5 lt	0.5 lt	0.74 lt	0.74 lt	0.5 lt
Model CWG-	10077	10151	30151	30375	30565	30750	31500	34000
Lubricant	L-EP2	HT-740-0	HT-740-0	HT-740-0	HT-740-0	HT-740-0	SP-460	SP-460
Q'ty	0.74 lt	0.74 lt	0.74 lt	1.36 lt	2.27 lt	3.41 lt	3.14 lt	3.14 lt

## ► Brake Replacement and Adjustment

- For CP-200/250/300/500/500T, CWG-30075 winches

There is no brake adjustment function. Once the brake disc is considerable worn, replace it with new one.

Condition: Brake distance is more than 1.5% of rope length to be wound-in during 1 min or the brake disc thickness is smaller than 8.5 mm, compared to the standard thickness of 9 mm

- For CP-750T/900T, CWG-10151/30151/30375/30565/30750/31500/34000 winches

If the brake disc thickness is smaller than 12 mm, replace it with new one, compared to the standard thickness of 14 mm, replace it with new one.

Condition: Brake distance is more than 1.5% of rope length to be wound-in during 1 minute.

Procedures: Step1. Loosen the adjusting nut "B" to have the nut "A" released

Step2. Rotate nut "A" clockwise to get a proper brake gap

0.35 mm for CWG-10151/30151

0.45 mm for CP-750T/900T and CWG-30375

0.6 mm for CWG-30565/30750/31500/34000

Step3. Tighten the adjusting nut "B"

Step4. At first, tighten the adjusting nut C and then release it by proper wraps

CWG-10151/30151.....9.5 wraps

CWG-30375.....5.5 wraps

CWG-30565/30750/31500/34000.....6.5 wraps

CP-750T/900T.....6.5 wraps

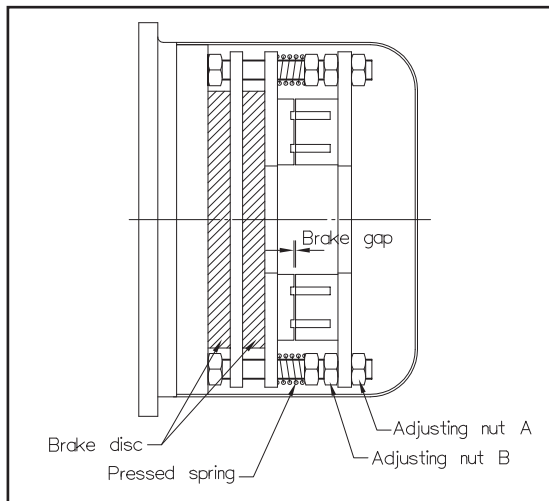

► Brake Specification

Model	Coil Volt. V	Brake Disc Diameter mm x q'ty	Resistance ohm	Brake Gap mm
CP-200	110	95 x 1	103	0.3
CP-250	110	95 x 2	103	0.45
CP-300	220	95 x 2	103	0.45
CP-500	220	95 x 2	228	0.45
CP-500T	220	95 x 2	228	0.45
CP-750T	380	150 x 1	84, 36, 48	0.45
CP-900T	380	150 x 1	84, 36, 48	0.45
CWG-10077	110	95 x 2	64	0.45
CWG-10151	DC 220	140 x 1	436	0.35
CWG-30075	220	95 x 2	434	0.45
CWG-30151	DC 220	140 x 1	436	0.35
CWG-30375	220	170 x 1	25, 11, 14	0.45
	380		96, 42, 54	
	415		105, 48, 60	
	440		115, 51, 65	
CWG-30565 CWG-30750 CWG-31500	220	188 x 2	28, 12, 15	0.6
	380		108, 48, 50	
	415		90, 40, 50	
	440		126, 56, 70	
CWG-34000	220	200 x 2	9, 4, 5	0.6
	380		27, 17, 15	
	415		41, 18, 23	
	440		152, 66, 83	

## VI. Cart Puller Capacity

### ► Choose the Right Winch

In most pulling applications you are dealing with a rolling road rather than pulling a dead weight. Resistance to rolling is mostly influenced by the load, rolling resistance, track gradient, track curvature, track conditions.

- **Load:** Calculate the total weight of the loaded cart to be moved simultaneously.
- **Rolling resistance:** Resistance to rolling is influenced by the wheel journals, type of lubrication used and the ambient temperature.
- **Track gradient:** For each one percent gradient, a rise of one meter for every 100 meter of track, the running line pull must be increased by 10 kg per ton.
- **Track curvature:** To overcome the effects of wheels binding against rails on curved sections of track, running line pull must be increased. For each degree of curvature, the running line pull must be increased by 1kg per ton.
- **Track conditions:** The condition of substandard track can vary considerably.

### ► Application Condition Example

- 1). Pulling of a rolling cart in and out of an oven using a single wire rope
- 2). 50 ton total load being moved included weight of cart
- 3). Steel cart wheels with precision wheel bearing
- 4). New track, 5° curvature and 2% gradient

Gradient Percentage	Gradient ( $\theta$ )
5%	3°
10%	6°
20%	11°
30%	17°
50%	26°
70%	35°
100%	45°

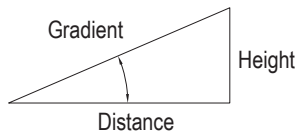

$$\text{Gradient (\%)} = \frac{\text{Height}}{\text{Distance}} \times 100 (\%)$$

A gradient of 10% is a rise of one meter in ten meters

### ► Pulling Capacity Required

50 ton.....	Total weight being moved
x (10 kg+20 kg+5 kg) 10kg.....	Pull required per ton being moved
<u>1,750 kg</u>	20kg.....For each one percent gradient, the running line pull must be increased by 10 kg/ton
	5kg.....For each one degree of curvature, the running line pull must be increased by 1 kg/ton
x 1.2	20%..... contingency for unpredictable track or cart conditions
<u>2,100 kg</u>	.....Minimum calculated cart puller capacity

## ► Horizontal Load Reversing

The horizontal load reversing allows 2 pieces of wire rope to be spooled onto the first layer of grooved drum. As one rope winds onto the drum and the other rope winds off an equal amount. It is important to know how each of the wire rope will be coming off of the drum, that allows the correct grooving to be provided.

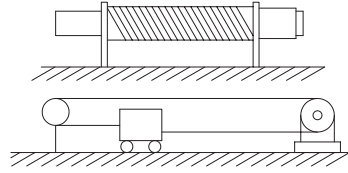

## VII. Wiring Diagram

### ► CP-200/250/300, CWG-10077 Winches

Standard Version

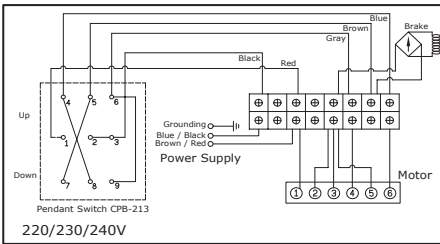

Switch with an emergency stop button

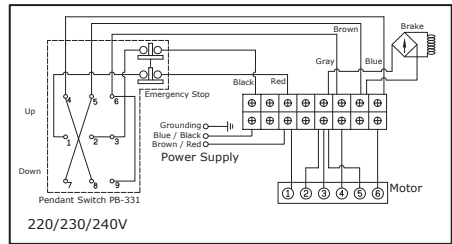

Low voltage control assembly and Switch with an emergency stop button

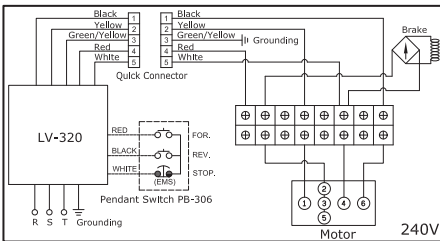

### ► CP-750T Winch

Standard Version

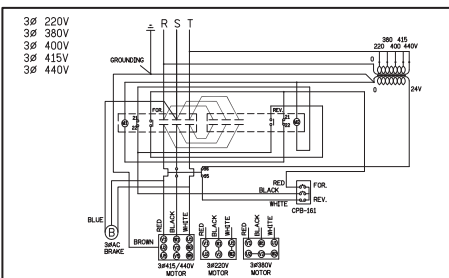

Switch with an emergency stop button

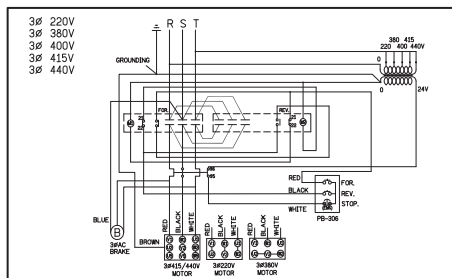



► **CP-500T Winch**

**Standard Version**

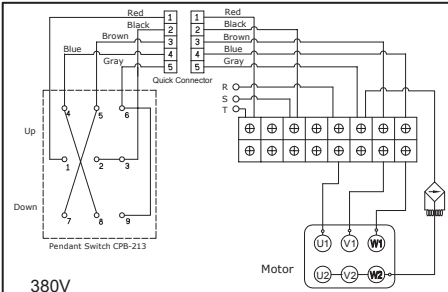

**Switch with an emergency stop button**

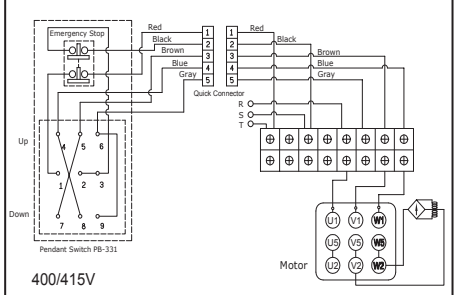
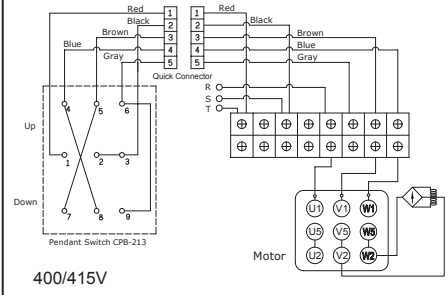
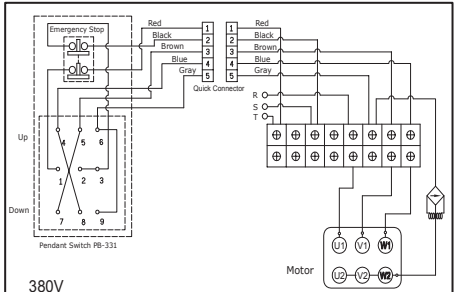

**Low voltage control assembly**

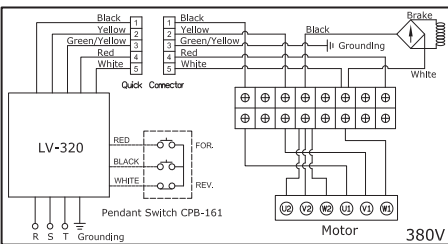

**Low voltage control assembly and Switch with an emergency stop button**

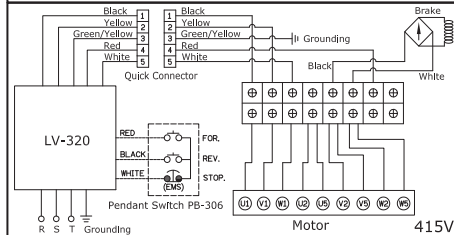
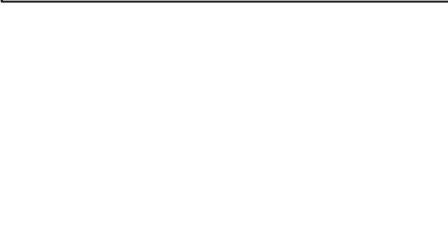
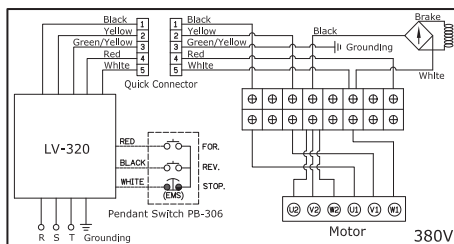

## ► CP-500 Winch

Standard Version

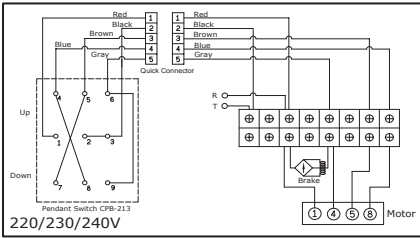

Switch with an emergency stop button

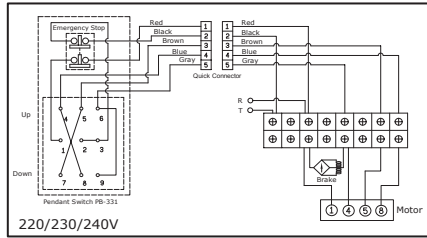

Low voltage control assembly and Switch with an emergency stop button

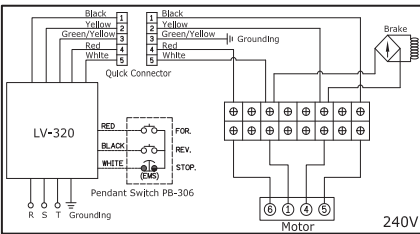

## ► CWG-10151 Winch

Standard Version

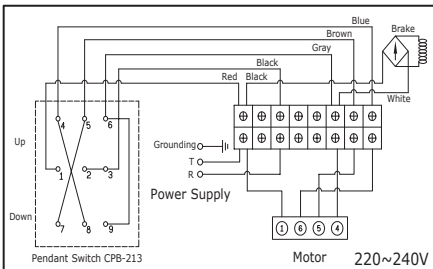

Switch with an emergency stop button

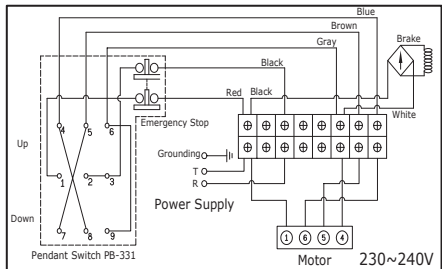

Low voltage control assembly and Switch with an emergency stop button

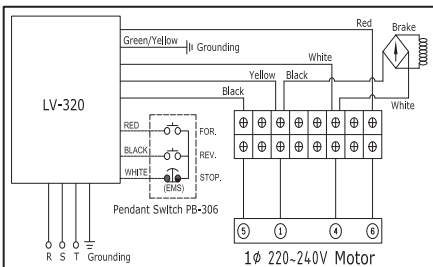

►  **CWG-30075 Winch**

**Standard Version**

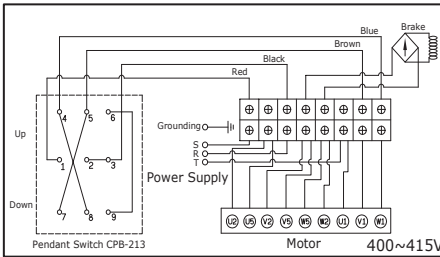
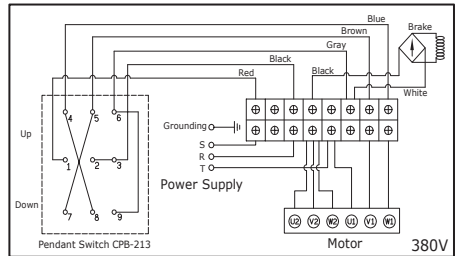
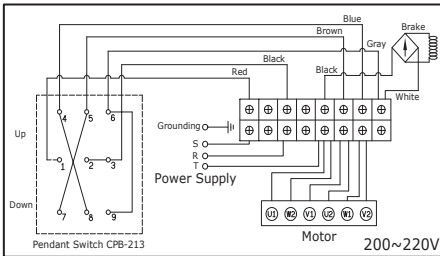

**Switch with an emergency stop button**

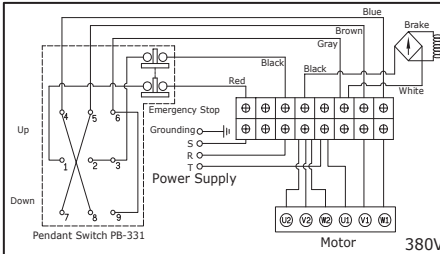

**Low voltage control assembly and Switch with an emergency stop button**

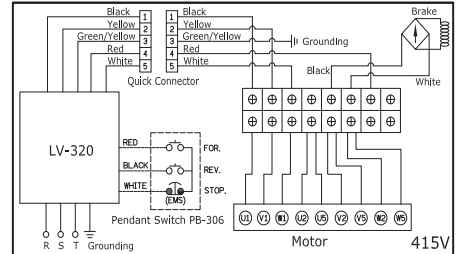

►  **CWG-30375/30565/30750/31500 Winches**

**Standard Version**

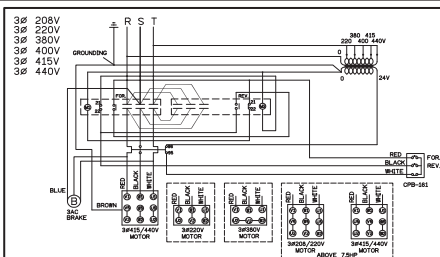

**Switch with an emergency stop button**

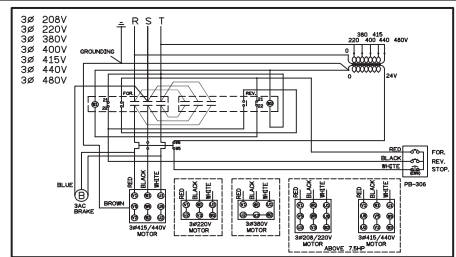

## ► CWG-30151 Winch

### Standard Version

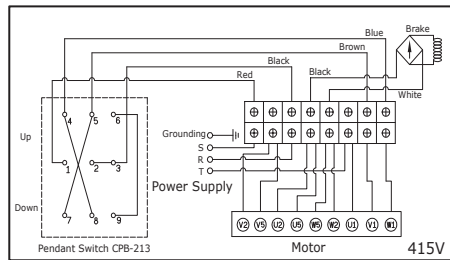
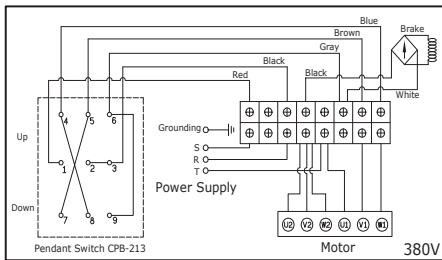

### Switch with an emergency stop button

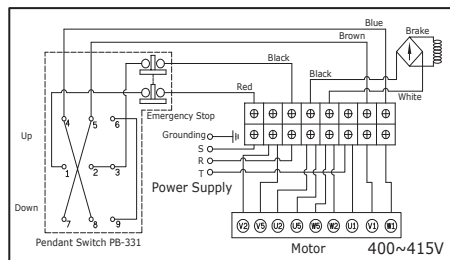
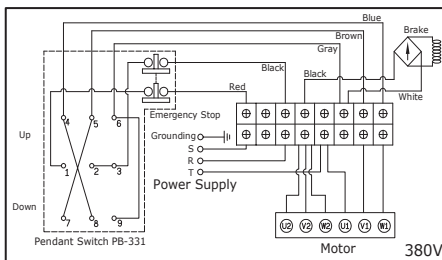

### Low voltage control assembly and Switch with an emergency stop button

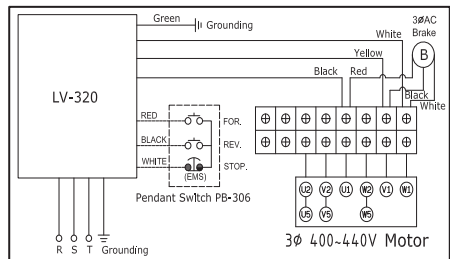
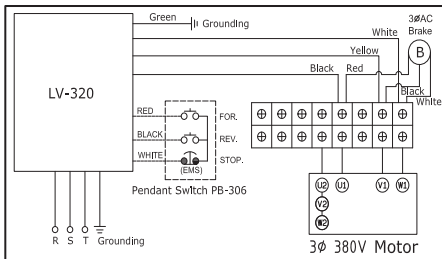

## ► CWG-34000 Winch

### Standard Version

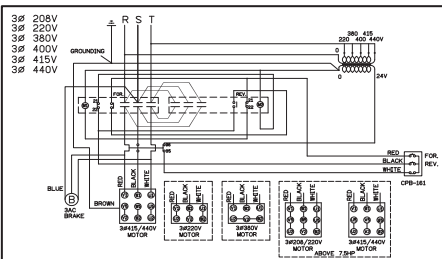

### Switch with an emergency stop button

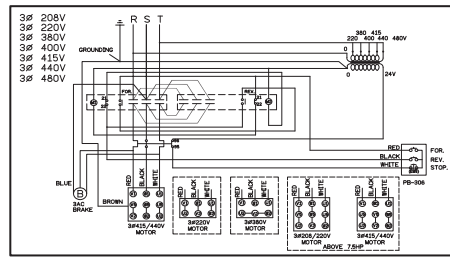

## VIII. Checking and Trouble Shooting

### ► Checking Reference

- Remark : 1. The specified person performs the checking of winch.  
 2. Divide the checking into daily checking and periodic checking.  
 3. The checking items and checking method in daily and periodic checking shall be carried out and different according to the using frequency.

Checking Items			Checking Methods	Classification of Checks			
				Daily	Periodical		
					3 Months/ 20 Hours	1 Year	3 Years or 250 Hours
1	Brake	Performance Wearing of lining, and pressed plate Brake or escaping of spring	Visual Decomposition check Decomposition check	▲			▲ ▲
2	Motor	Condition of insulation Staining , damage	Measuring,10MΩ min Visual	▲	▲		
3	Remote control	Working Outer damage of cord and its length Condition of insulation	Manual Visual Measuring,10MΩ min	▲ ▲	▲		
4	Wirings	Attaching condition of earth line Wrong rotary direction-winding	Visual Visual	▲ ▲			
5	Wire rope	Kink phenomena Broken wires more than 10% Decreasing of diameter more than 7% Deforming or corrosion	Visual Visual Visual Visual	▲ ▲ ▲ ▲			
6	Weight hook and tackle block	Distortion Damage Loosening	Visual Visual Visual	▲ ▲ ▲			
7	Drum	Rupture of flange Wearing	Visual Visual	▲	▲ ▲		
8	Gear trains	Damage , warning Condition of oil feeding Lubrication for couplings	Visual Measuring Measuring	▲		▲ ▲	
9	Fastenings	Loosening	Manual	▲		▲	
10	Marking	Label and the like	Manual	▲			

## ► Trouble Shootings

Checking the winch for smooth operation by pressing ↑ or ↓ button of pendant switch.

When winch fails to start after several attempts, or if any defective operation to be happened, check followings.

Symptom	Possible Cause	Remedy
No reaction	Wrong connection	Connect correctly
	No power source or wrong ratings	Check power source
Motor buzzes but does not start	Brake does not open	Check brake assembly
	Wrong connection	Connect correctly
	Burnt motor	Rewind or replace motor
Failing in restarting	Overload	Reduce the load
	Brake does not open	Check brake assembly
	Damaged centrifugal switch for 1 phase motor	Replace centrifugal switch
	Brake disc wear down	Replace brake disc
Failing in lifting a load within the lifting capacity	Considerable voltage drop ( It can provoke non-opening of brake)	Check voltage to make sure the voltage shall be falling within 5% of rated voltage
	Brake does not open	Check brake assembly
	Burnt or communicated motor	Rewind or replace motor
	Wrong power lead in size and length	Collect the motor lead in size and use a bigger section of lead for longer distance
Brake does not open completely	Considerable voltage drop ( It can provoke non-opening of brake)	Check voltage to make sure the voltage shall be falling within 5% of rated voltage
	Damaged brake coil	Measure the standard value and replace brake coil
	Improper brake gap	Adjust brake gap
	Brake disc wear down	Replace brake disc
Crossed rotation	Wrong connection	Connect the wirings correctly
Grease leakage	Damaged oil seal	Replace oil seal



# COMEUP

---

## COMEUP INDUSTRIES INC.

No.139, Jieyukeng Rd., Ruifang Dist., New Taipei City 22453, Taiwan

TEL:+886-2-24971788 FAX:+886-2-24971699

Email: [info@comeup.com.tw](mailto:info@comeup.com.tw)

<http://www.comeupwinch.com>

PN 881945 Ver:07

Specifications subject to change without notice